



SQUARE-S

Lavov surface downlight from the family SQUARE-S B with a power of 35W and a beam angle of 20°. Finished in White colour. Dimensions 113x113x120mm. With a total lumen output of 2800lm and a luminous efficacy of 80lm/W. Made in Die cast aluminium. Driver DALI. CCT 4000K. IP65.

Dimensions

Product dimensions (mm) **113x113x120mm**

Scheme

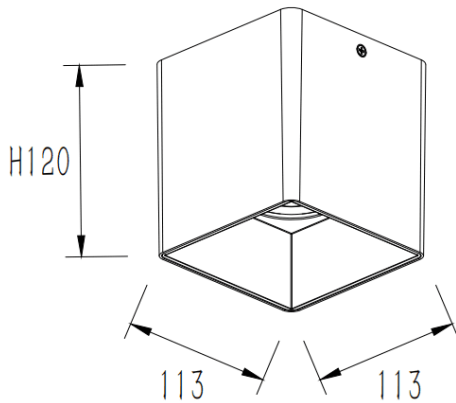

Item code	86.SD03.3413.01
Product type	Indoor
Category	Surface Downlights
Family	SQUARE-S
Pictograms	

Product	
Real power (W)	35
Real luminous flux (Lm)	2800
Luminous efficiency (Lm/W)	80
Beam angle (º)	20
Life time (h)	50000h L80B10
IP	IP65
Colour	White
Control gear included	Yes
Control gear	DALI
Colour temperature (K)	4000
Colour consistency (SDCM)	SDCM<3
CRI	80