

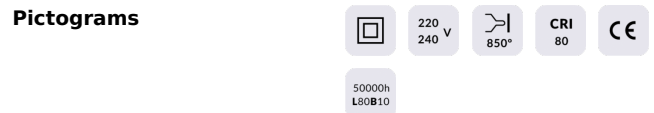

### Rock down

Lavov surface downlight from the family Rock down with a switchable power of 10/15/20W and an optics 105,5° degrees . Switchable CCT 3000/4000/6000K. With a total lumen output of 1200/1800/2400lm and a luminous efficiency of 120lm/W. Color stability SDCM80.

<b>Item code</b>	<b>86.SD07.2303.01</b>
<b>Product type</b>	<b>Indoor</b>
<b>Category</b>	<b>Surface Downlights</b>
<b>Family</b>	<b>Rock</b>
<b>Subfamily</b>	<b>Rock down</b>
<b>Pictograms</b>	



### Product

<b>Real power (W)</b>	<b>10/15/20</b>
<b>Real luminous flux (Lm)</b>	<b>1200/1800/2400</b>
<b>Luminous efficiency (Lm/W)</b>	<b>120</b>
<b>Beam angle (°)</b>	<b>105,5°</b>
<b>IP</b>	<b>54</b>
<b>Colour</b>	<b>white</b>
<b>Control gear included</b>	<b>yes</b>
<b>Control gear</b>	<b>DALI</b>
<b>Power Factor</b>	<b>&gt;0,9</b>
<b>Flicker Free</b>	<b>yes</b>
<b>Colour temperature (K)</b>	<b>3000/4000/6000</b>
<b>Colour consistency (SDCM)</b>	<b>SDCM&lt;3</b>
<b>CRI</b>	<b>&gt;80</b>
<b>IK</b>	<b>IK10</b>

### Dimensions

**Product dimensions (mm)**    **Ø320xH57mm**

### Scheme

