



Rock up&down

Lavov surface downlight from the family Rock up&down with a switchable power of 8/10/15W and an optics 150° down, 110° up degrees. Switchable CCT 3000/4000/6000K. With a total lumen output of 960/1200/1800lm and a luminous efficiency of 120lm/W. Color stability SDCM3. CCT 3000/4000/6000K. On-off driver. Made in PC housing and PC cover and finished in white color. IP54 and IK10 degree of protection. CRI > 80.

Dimensions

Product dimensions (mm) Ø300xH57mm

Scheme

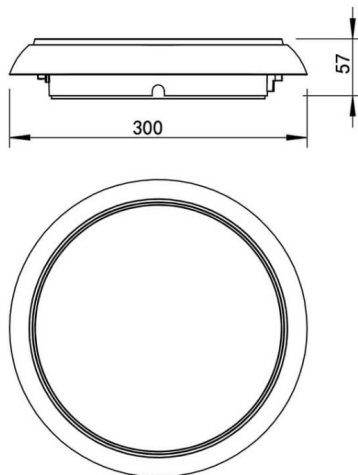

Item code	86.SD09.1301.01
Product type	Indoor
Category	Surface Downlights
Family	Rock
Subfamily	Rock up&down
Pictograms	

Product	
Real power (W)	8/10/15
Real luminous flux (Lm)	960/1200/1800
Luminous efficiency (Lm/W)	120
Beam angle (º)	150° down, 110° up
IP	54
Colour	white
Control gear included	yes
Control gear	On-off
Power Factor	>0,9
Flicker Free	yes
Colour temperature (K)	3000/4000/6000
Colour consistency (SDCM)	SDCM<3
CRI	>80
IK	IK10