

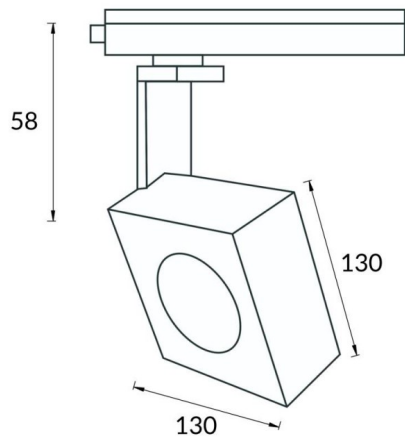

Square

Lavov Tracklight from the family Square with a power of 30W and an optic of 12degrees with a total lumen output of 1944 lm and an efficiency of 64,8 lm/W. CCT 3000 Kelvin. Made in Die cast aluminium and finished in Black colour. DALI driver.

Scheme



Item code	86.T007.1313.02
Product type	Indoor
Category	Tracklights
Family	Disc & Square
Subfamily	Square
Pictograms	

Product

Real power (W)	30
Real luminous flux (Lm)	1944
Luminous efficiency (Lm/W)	64.8
Beam angle (°)	12
Life time (h)	50000h L80B10
IP	20
Electrical class insulation	Class I
Operating temperature	-20 +35
Colour	Black
Chip Brand	Philip
Control gear included	yes
Control gear	DALI
Light source	LED
Type of LED	COB
Colour temperature (K)	3000
Colour consistency (SDCM)	SDCM3
CRI	80