



Luxball

Lavov Tracklight from the family Luxball with a power of 30W and an optic of 24 degrees with a total lumen output of 1870 lm and an efficiency of 62,3 lm/W. CCT 3000 Kelvin. Made in Die Cast Aluminum and finished in Black colour. DALI driver.

Item code	86.T008.2323.02
Product type	Indoor
Category	Tracklights
Family	Luxball
Subfamily	Luxball
Pictograms	

Scheme

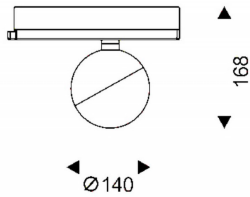

Photometry

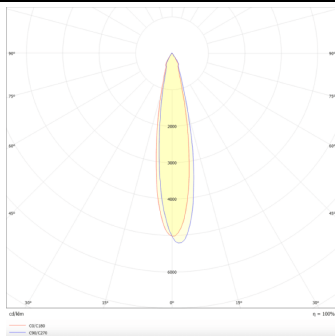

Product	
Real power (W)	30
Real luminous flux (Lm)	1870
Luminous efficiency (Lm/W)	62.33
Beam angle (°)	24
Life time (h)	50000h L80B10
IP	20
Electrical class insulation	Class I
Operating temperature	-20 +35
Colour	Black
Chip Brand	Philip
Control gear included	yes
Control gear	DALI
Colour temperature (K)	3000
Colour consistency (SDCM)	SDCM<3
CRI	90