



Luxball

Lavov Tracklight from the family Luxball with a power of 30W and an optic of 24 degrees with a total lumen output of 1870 lm and an efficiency of 62,3 lm/W. CCT 4000 Kelvin. Made in Die Cast Aluminum and finished in White colour.ON-OFF driver.

Item code 86.T008.2421.01

Product type Indoor

Category Tracklights

Family Luxball

Subfamily Luxball

Pictograms



Scheme

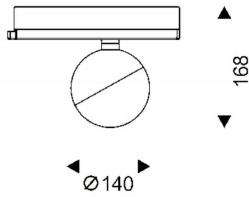

Photometry

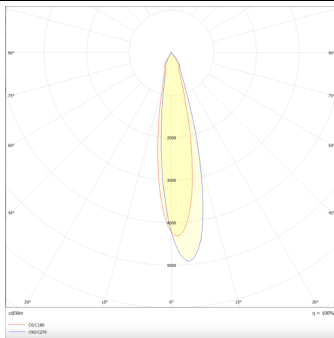

Product

Real power (W) 30

Real luminous flux (Lm) 1870

Luminous efficiency (Lm/W) 62.33

Beam angle (°) 24

Life time (h) 50000h L80B10

IP 20

Electrical class insulation Class I

Operating temperature -20 +35

Colour White

Chip Brand Philip

Control gear included yes

Control gear ON-OFF

Colour temperature (K) 4000

Colour consistency (SDCM) SDCM<3

CRI 90