



### Luxball

Lavov Tracklight from the family Luxball with a power of 30W and an optic of 24 degrees with a total lumen output of 1870 lm and an efficiency of 62,3 lm/W. CCT 4000 Kelvin. Made in Die Cast Aluminum and finished in Black colour.ON-OFF driver.

**Item code** 86.T008.2421.02

**Product type** Indoor

**Category** Tracklights

**Family** Luxball

**Subfamily** Luxball

**Pictograms**



### Scheme

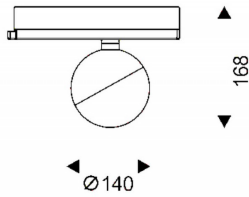

### Photometry

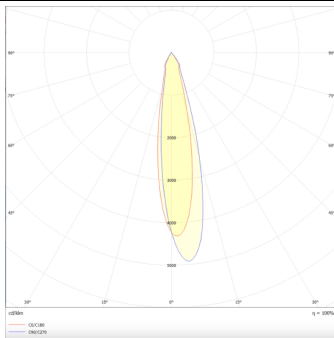

### Product

**Real power (W)** 30

**Real luminous flux (Lm)** 1870

**Luminous efficiency (Lm/W)** 62.33

**Beam angle (°)** 24

**Life time (h)** 50000h L80B10

**IP** 20

**Electrical class insulation** Class I

**Operating temperature** -20 +35

**Colour** Black

**Chip Brand** Philip

**Control gear included** yes

**Control gear** ON-OFF

**Colour temperature (K)** 4000

**Colour consistency (SDCM)** SDCM<3

**CRI** 90