



GAP D-Smart

Lavov tracklight from the family GAP D-Smart with a power of 2x10W and a optic distribution 36°. With a total lumen output of 1800lm and an efficiency of 100lm/W. Manufactured in Die Cast Aluminum and finished in White colour. Dimable Casambi ready driver.

Item code	86.T014.1339.01
Product type	Indoor
Category	Tracklights
Family	GAP
Subfamily	GAP D-Smart
Pictograms	

Scheme

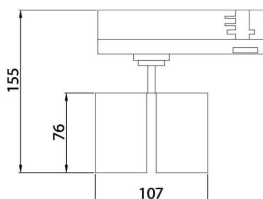

Product	
Real power (W)	2x10
Real luminous flux (Lm)	1800
Luminous efficiency (Lm/W)	100
Beam angle (°)	36°
Life time (h)	50000h L80B11
IP	20
Electrical class insulation	Class II
Operating temperature	15
Colour	White
Chip Brand	Philip
Control gear included	yes
Control gear	Dimable Casambi ready
Colour temperature (K)	3000
Colour consistency (SDCM)	SDCM<3
CRI	90