



Tube tracklight D55 H115

Lavov tracklight from the family Tube tracklight D55 H115 with a power of 20W and a beam angle of 36°. With a real lumen output of 2000lm and an efficiency of 100lm/W. Made in Die cast aluminium and finished in black color. ON-OFF, No-dim.

Item code	86.TL01.A331.02
Product type	Indoor
Category	Tracklights
Family	Magnetic Track
Subfamily	Tube tracklight D55 H115
Pictograms	

Scheme

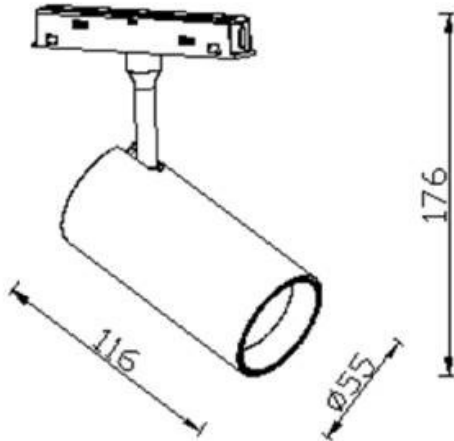

Product	
Real power (W)	20
Real luminous flux (Lm)	2000lm
Luminous efficiency (Lm/W)	100
Beam angle (º)	36°
Colour	black
Chip Brand	EPISTAR
Control gear included	YES
Control gear	ON-OFF, No-dim
Average life time (h)	50000hrs L80 B10
Colour temperature (K)	3000
Colour consistency (SDCM)	SDCM<3
CRI	90