

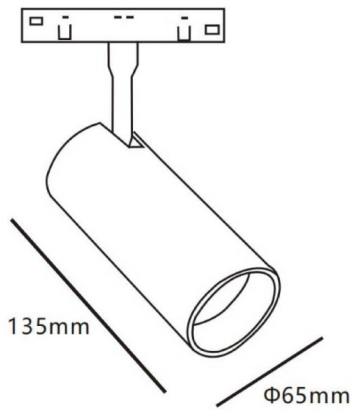



### Tube tracklight D65 H135

Lavov tracklight from the family Tube tracklight D65 H135 with a power of 30W and a beam angle of 36°. With a real lumen output of 3000lm and an efficiency of 100lm/W. Made in Die cast aluminium and finished in white color. DALI Brightness Dim 0.1~100%.

### Scheme



Item code	86.TL01.B333.01
Product type	Indoor
Category	Tracklights
Family	Magnetic Track
Subfamily	Tube tracklight D65 H135
Pictograms	

Product	
Real power (W)	30
Real luminous flux (Lm)	3000lm
Luminous efficiency (Lm/W)	100
Beam angle (°)	36°
Colour	white
Chip Brand	EPISTAR
Control gear included	YES
Control gear	DALI Brightness Dim 0.1~100%
Flicker Free	Yes
Light source	LED
Type of LED	SMD
Average life time (h)	50000hrs L80 B10
Colour temperature (K)	3000
Colour consistency (SDCM)	SDCM3
CRI	90