

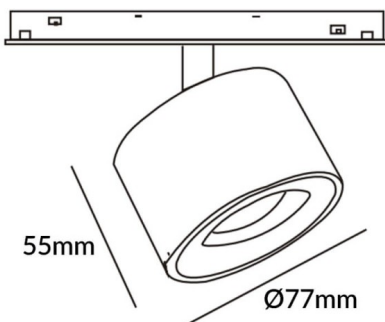



---

**Scheme**

---



---

**Disc tracklight DIAM 77x55mm**

---

Lavov tracklight from the family Disc tracklight DIAM 60x48mm with a power of 12W and a beam angle of 36°. With a real lumen output of 1200lm and an efficiency of 100lm/W. Made in Die cast aluminium and finished in black color. DALI Tunable White Dim 0.1~100%.

<b>Item code</b>	<b>86.TL01.Q330.02</b>
<b>Product type</b>	<b>Indoor</b>
<b>Category</b>	<b>Tracklights</b>
<b>Family</b>	<b>Magnetic Track</b>
<b>Subfamily</b>	<b>Disc tracklight DIAM 77x55mm</b>
<b>Pictograms</b>	

<b>Product</b>	
<b>Real power (W)</b>	<b>12</b>
<b>Real luminous flux (Lm)</b>	<b>1200lm</b>
<b>Luminous efficiency (Lm/W)</b>	<b>100</b>
<b>Beam angle (°)</b>	<b>36°</b>
<b>Colour</b>	<b>black</b>
<b>Chip Brand</b>	<b>FMSP924-1 12W</b>
<b>Control gear included</b>	<b>YES</b>
<b>Control gear</b>	<b>DALI Tunable White Dim 0.1~100%</b>
<b>Flicker Free</b>	<b>Yes</b>
<b>Light source</b>	<b>LED</b>
<b>Type of LED</b>	<b>SMD</b>
<b>Average life time (h)</b>	<b>50000hrs L80 B10</b>
<b>Colour temperature (K)</b>	<b>3000</b>
<b>Colour consistency (SDCM)</b>	<b>SDCM3</b>
<b>CRI</b>	<b>90</b>