



### Disc Smart

Lavov Tracklight from the family Disc with a power of 30W and an optic of 12degrees with a total lumen output of 1944 lm and an efficiency of 64,8 lm/W. CCT 3000 Kelvin. Made in Die cast aluminium and finished in White colour. CASAMBI ready driver. .

Item code	86.TST6.1319.01
Product type	Indoor
Category	Tracklights
Family	Disc & Square
Subfamily	Disc Smart
Pictograms	

### Scheme

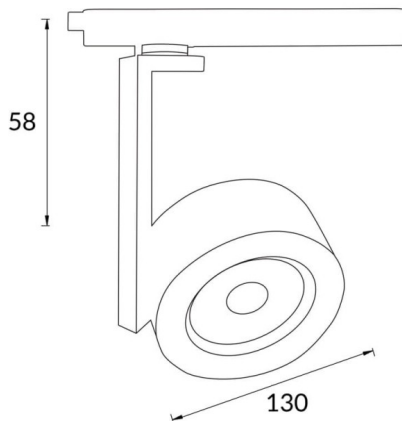

Product	
Real power (W)	30
Real luminous flux (Lm)	1944
Luminous efficiency (Lm/W)	64.8
Beam angle (°)	12
Life time (h)	50000h L80B10
IP	20
Electrical class insulation	Class I
Operating temperature	-20 +35
Colour	White
Chip Brand	Philip
Control gear included	yes
Control gear	DALI Casamby ready
Light source	LED
Type of LED	COB
Colour temperature (K)	3000
Colour consistency (SDCM)	SDCM3
CRI	80