



Disc Smart

Lavov Tracklight from the family Disc with a power of 30W and an optic of 24degrees with a total lumen output of 1709 lm and an efficiency of 56,97 lm/W. CCT 3000 Kelvin. Made in Die cast aluminium and finished in White colour. CASAMBI ready driver. .

Item code	86.TST6.1329.01
Product type	Indoor
Category	Tracklights
Family	Disc & Square
Subfamily	Disc Smart

Pictograms



Scheme

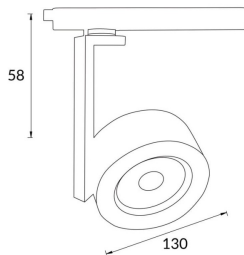

Product

Real power (W)	30
Real luminous flux (Lm)	1709
Luminous efficiency (Lm/W)	56.96
Beam angle (°)	24
Life time (h)	50000h L80B10
IP	20
Electrical class insulation	Class I
Operating temperature	-20 +35
Colour	White
Chip Brand	Philip
Control gear included	yes
Control gear	DALI Casamby ready
Colour temperature (K)	3000
Colour consistency (SDCM)	SDCM<3
CRI	80