

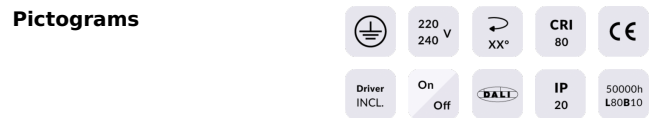

Disc Smart

Lavov Tracklight from the family Disc with a power of 30W and an optic of 40degrees with a total lumen output of 2996 lm and an efficiency of 99,87 lm/W. CCT 3000 Kelvin. Made in Die cast aluminium and finished in Black colour. CASAMBI ready driver. .

Item code	86.TST6.1339.02
Product type	Indoor
Category	Tracklights
Family	Disc & Square
Subfamily	Disc Smart
Pictograms	



Scheme

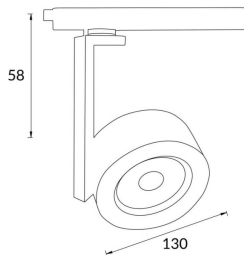

Product	
Real power (W)	30
Real luminous flux (Lm)	2996
Luminous efficiency (Lm/W)	99.86
Beam angle (°)	40
Life time (h)	50000h L80B10
IP	20
Electrical class insulation	Class I
Operating temperature	-20 +35
Colour	Black
Chip Brand	Philip
Control gear included	yes
Control gear	DALI Casamby ready
Colour temperature (K)	3000
Colour consistency (SDCM)	SDCM<3
CRI	80