



### Disc Smart

Lavov Tracklight from the family Disc with a power of 30W and an optic of 12degrees with a total lumen output of 1944 lm and an efficiency of 64,8 lm/W. CCT 4000 Kelvin. Made in Die cast aluminium and finished in Black colour. CASAMBI ready driver. .

<b>Item code</b>	<b>86.TST6.1419.02</b>
<b>Product type</b>	<b>Indoor</b>
<b>Category</b>	<b>Tracklights</b>
<b>Family</b>	<b>Disc &amp; Square</b>
<b>Subfamily</b>	<b>Disc Smart</b>

### Pictograms



### Scheme

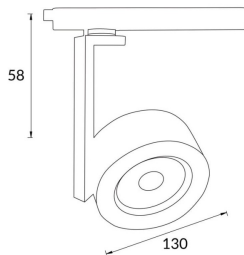

### Product

<b>Real power (W)</b>	<b>30</b>
<b>Real luminous flux (Lm)</b>	<b>1944</b>
<b>Luminous efficiency (Lm/W)</b>	<b>64.8</b>
<b>Beam angle (°)</b>	<b>12</b>
<b>Life time (h)</b>	<b>50000h L80B10</b>
<b>IP</b>	<b>20</b>
<b>Electrical class insulation</b>	<b>Class I</b>
<b>Operating temperature</b>	<b>-20 +35</b>
<b>Colour</b>	<b>Black</b>
<b>Chip Brand</b>	<b>Philip</b>
<b>Control gear included</b>	<b>yes</b>
<b>Control gear</b>	<b>DALI Casamby ready</b>
<b>Colour temperature (K)</b>	<b>4000</b>
<b>Colour consistency (SDCM)</b>	<b>SDCM&lt;3</b>
<b>CRI</b>	<b>80</b>