



### Luxball Smart

Lavov Tracklight from the family Luxball with a power of 30W and an optic of 24 degrees with a total lumen output of 1870 lm and an efficiency of 62,3 lm/W. CCT 3000 Kelvin. Made in Die Cast Aluminum and finished in White colour. CASAMBI ready driver. .

<b>Item code</b>	<b>86.TST8.2329.01</b>
------------------	------------------------

<b>Product type</b>	<b>Indoor</b>
---------------------	---------------

<b>Category</b>	<b>Tracklights</b>
-----------------	--------------------

<b>Family</b>	<b>Luxball</b>
---------------	----------------

<b>Subfamily</b>	<b>Luxball Smart</b>
------------------	----------------------

<b>Pictograms</b>	    
	    



### Scheme

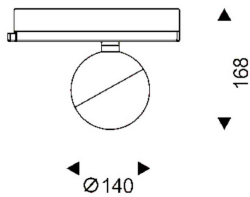

### Product

<b>Real power (W)</b>	<b>30</b>
-----------------------	-----------

<b>Real luminous flux (Lm)</b>	<b>1870</b>
--------------------------------	-------------

<b>Luminous efficiency (Lm/W)</b>	<b>62.33</b>
-----------------------------------	--------------

<b>Beam angle (°)</b>	<b>24</b>
-----------------------	-----------

<b>Life time (h)</b>	<b>50000h L80B10</b>
----------------------	----------------------

<b>IP</b>	<b>20</b>
-----------	-----------

<b>Electrical class insulation</b>	<b>Class I</b>
------------------------------------	----------------

<b>Operating temperature</b>	<b>-20 +35</b>
------------------------------	----------------

<b>Colour</b>	<b>White</b>
---------------	--------------

<b>Chip Brand</b>	<b>Philip</b>
-------------------	---------------

<b>Control gear included</b>	<b>yes</b>
------------------------------	------------

<b>Control gear</b>	<b>DALI Casamby ready</b>
---------------------	---------------------------

<b>Colour temperature (K)</b>	<b>3000</b>
-------------------------------	-------------

<b>Colour consistency (SDCM)</b>	<b>SDCM&lt;3</b>
----------------------------------	------------------

<b>CRI</b>	<b>90</b>
------------	-----------