



Luxball Smart

Lavov Tracklight from the family Luxball with a power of 30W and an optic of 40 degrees with a total lumen output of 1870 lm and an efficiency of 62,3 lm/W. CCT 4000 Kelvin. Made in Die Cast Aluminum and finished in Black colour. CASAMBI ready driver. .

Item code	86.TST8.2439.02
------------------	------------------------

Product type	Indoor
---------------------	---------------

Category	Tracklights
-----------------	--------------------

Family	Luxball
---------------	----------------

Subfamily	Luxball Smart
------------------	----------------------

Pictograms	



Scheme

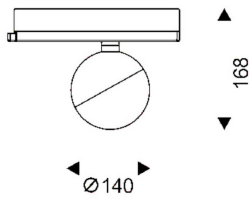

Product

Real power (W)	30
-----------------------	-----------

Real luminous flux (Lm)	1870
--------------------------------	-------------

Luminous efficiency (Lm/W)	62.33
-----------------------------------	--------------

Beam angle (°)	40
-----------------------	-----------

Life time (h)	50000h L80B10
----------------------	----------------------

IP	20
-----------	-----------

Electrical class insulation	Class I
------------------------------------	----------------

Operating temperature	-20 +35
------------------------------	----------------

Colour	Black
---------------	--------------

Chip Brand	Philip
-------------------	---------------

Control gear included	yes
------------------------------	------------

Control gear	DALI Casamby ready
---------------------	---------------------------

Colour temperature (K)	4000
-------------------------------	-------------

Colour consistency (SDCM)	SDCM<3
----------------------------------	------------------

CRI	90
------------	-----------