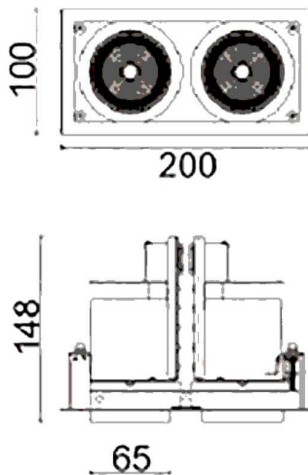

**D-TUBE2**

Downlight Lavov de la familia D-TUBE con una potencia de 36W, CRI>80 y un haz de 12 grados. Fabricado en aluminio inyectado a presión acabado en color Negro. Flujo real de 2800lm. Eficacia luminosa de 77,77lm/W. DALI driver.

Código artículo	86.D011.1313.02
Tipo de producto	Indoor
Categoría	Downlights
Familia	D-TUBE
Subfamilia	D-TUBE2
Pictograms	

Esquema

Producto	
Potencia real (W)	36
Flujo luminoso real (lm)	2800
Eficacia luminosa (lm/W)	77.77777777777999
Ángulo de apertura	12
Life time (h)	50000 h L80B10
IP	20
Color	Negro
Driver incluido	Si
Equipo	DALI
Flicker Free	Si
Light source	LED
Type of LED	COB
Temperatura de color (K)	3000
Consistencia de color (SDCM)	SDCM<3
CRI	80