

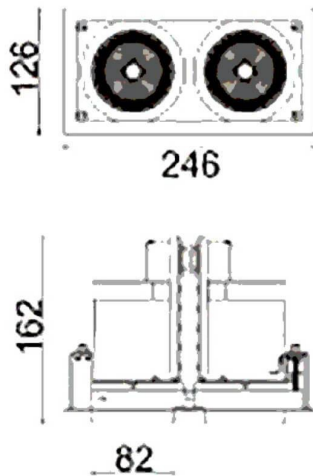

D-TUBE2

Downlight Lavov de la familia D-TUBE con una potencia de 60W, CRI>80 y un haz de 40 grados. Fabricado en aluminio inyectado a presión acabado en color Negro. Flujo real de 4860lm. Eficacia luminosa de 81lm/W. ON/OFF driver.

Código artículo	86.D011.2331.02
Tipo de producto	Indoor
Categoría	Downlights
Familia	D-TUBE
Subfamilia	D-TUBE2
Pictograms	

Esquema

Producto	
Potencia real (W)	60
Flujo luminoso real (lm)	4860
Eficacia luminosa (lm/W)	81
Ángulo de apertura	40
Life time (h)	50000 h L80B10
IP	20
Color	Negro
Driver incluido	Si
Equipo	ON/OFF
Flicker Free	Si
Light source	LED
Type of LED	COB
Temperatura de color (K)	3000
Consistencia de color (SDCM)	SDCM<3
CRI	80