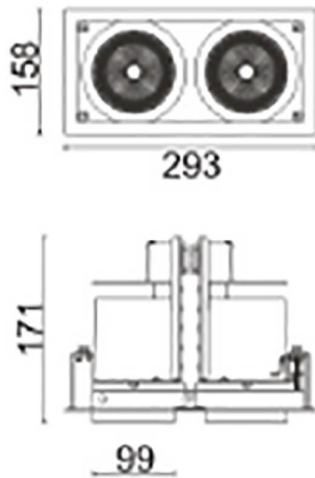

**D-TUBE2**

Downlight Lavov de la familia D-TUBE con una potencia de 70W, CRI>80 y un haz de 40 grados. Fabricado en aluminio inyectado a presión acabado en color Negro. Flujo real de 6140lm. Eficacia luminosa de 87,71lm/W. ON/OFF driver.

| | |
|-------------------------|---|
| Código artículo | 86.D011.3431.02 |
| Tipo de producto | Indoor |
| Categoría | Downlights |
| Familia | D-TUBE |
| Subfamilia | D-TUBE2 |
| Pictograms |  |

Esquema

| | |
|-------------------------------------|---------------------------|
| Producto | |
| Potencia real (W) | 70 |
| Flujo luminoso real (lm) | 6140 |
| Eficacia luminosa (lm/W) | 87.714285714286007 |
| Ángulo de apertura | 40 |
| Life time (h) | 50000 h L80B10 |
| IP | 20 |
| Color | Negro |
| Driver incluido | Si |
| Equipo | ON/OFF |
| Flicker Free | Si |
| Light source | LED |
| Type of LED | COB |
| Temperatura de color (K) | 4000 |
| Consistencia de color (SDCM) | SDCM<3 |
| CRI | 80 |