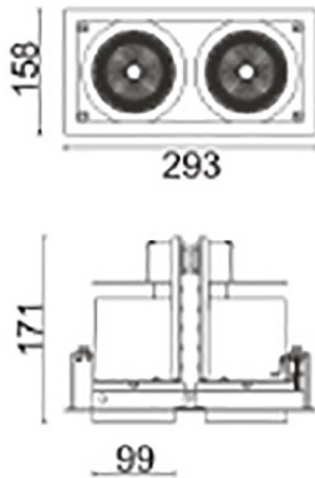

**D-TUBE2**

Downlight Lavov de la familia D-TUBE con una potencia de 70W, CRI>80 y un haz de 40 grados. Fabricado en aluminio inyectado a presión acabado en color Negro. Flujo real de 6140lm. Eficacia luminosa de 87,71lm/W. DALI driver.

<b>Código artículo</b>	<b>86.D011.3433.02</b>
<b>Tipo de producto</b>	<b>Indoor</b>
<b>Categoría</b>	<b>Downlights</b>
<b>Familia</b>	<b>D-TUBE</b>
<b>Subfamilia</b>	<b>D-TUBE2</b>
<b>Pictograms</b>	

**Esquema**

<b>Producto</b>	
<b>Potencia real (W)</b>	<b>70</b>
<b>Flujo luminoso real (lm)</b>	<b>6140</b>
<b>Eficacia luminosa (lm/W)</b>	<b>87.714285714286007</b>
<b>Ángulo de apertura</b>	<b>40</b>
<b>Life time (h)</b>	<b>50000 h L80B10</b>
<b>IP</b>	<b>20</b>
<b>Color</b>	<b>Negro</b>
<b>Driver incluido</b>	<b>Si</b>
<b>Equipo</b>	<b>DALI</b>
<b>Flicker Free</b>	<b>Si</b>
<b>Light source</b>	<b>LED</b>
<b>Type of LED</b>	<b>COB</b>
<b>Temperatura de color (K)</b>	<b>4000</b>
<b>Consistencia de color (SDCM)</b>	<b>SDCM&lt;3</b>
<b>CRI</b>	<b>80</b>