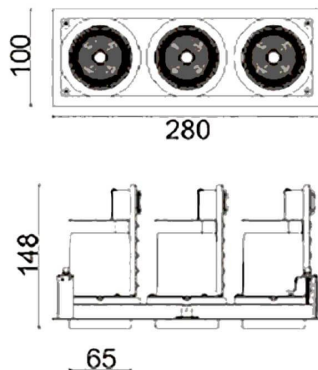

**D-TUBE3**

Downlight Lavov de la familia D-TUBE con una potencia de 54W, CRI>80 y un haz de 12 grados. Fabricado en aluminio inyectado a presión acabado en color Blanco. Flujo real de 4290lm. Eficacia luminosa de 79,44lm/W. DALI driver.

<b>Código artículo</b>	<b>86.D012.1413.01</b>
<b>Tipo de producto</b>	<b>Indoor</b>
<b>Categoría</b>	<b>Downlights</b>
<b>Familia</b>	<b>D-TUBE</b>
<b>Subfamilia</b>	<b>D-TUBE3</b>
<b>Pictograms</b>	

**Esquema**

<b>Producto</b>	
<b>Potencia real (W)</b>	<b>54</b>
<b>Flujo luminoso real (lm)</b>	<b>4290</b>
<b>Eficacia luminosa (lm/W)</b>	<b>79.444444444444002</b>
<b>Ángulo de apertura</b>	<b>12</b>
<b>Life time (h)</b>	<b>50000 h L80B10</b>
<b>IP</b>	<b>20</b>
<b>Color</b>	<b>Blanco</b>
<b>Driver incluido</b>	<b>Si</b>
<b>Equipo</b>	<b>DALI</b>
<b>Flicker Free</b>	<b>Si</b>
<b>Light source</b>	<b>LED</b>
<b>Type of LED</b>	<b>COB</b>
<b>Temperatura de color (K)</b>	<b>4000</b>
<b>Consistencia de color (SDCM)</b>	<b>SDCM&lt;3</b>
<b>CRI</b>	<b>80</b>