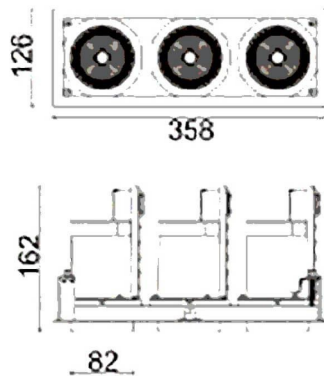

**D-TUBE3**

Downlight Lavov de la familia D-TUBE con una potencia de 90W, CRI>80 y un haz de 40 grados. Fabricado en aluminio inyectado a presión acabado en color Negro. Flujo real de 7290lm. Eficacia luminosa de 81lm/W. DALI driver.

|                         |   |
|-------------------------|---|
| <b>Código artículo</b>  | <b>86.D012.2333.02</b>  |
| <b>Tipo de producto</b> | <b>Indoor</b>   |
| <b>Categoría</b>        | <b>Downlights</b>   |
| <b>Familia</b>          | <b>D-TUBE</b>   |
| <b>Subfamilia</b>       | <b>D-TUBE3</b>  |
| <b>Pictograms</b>       |  |

**Esquema**

|                                     |                       |
|-------------------------------------|-----------------------|
| <b>Producto</b>                     |                       |
| <b>Potencia real (W)</b>            | <b>90</b>             |
| <b>Flujo luminoso real (lm)</b>     | <b>7290</b>           |
| <b>Eficacia luminosa (lm/W)</b>     | <b>81</b>             |
| <b>Ángulo de apertura</b>           | <b>40</b>             |
| <b>Life time (h)</b>                | <b>50000 h L80B10</b> |
| <b>IP</b>                           | <b>20</b>             |
| <b>Color</b>                        | <b>Negro</b>          |
| <b>Driver incluido</b>              | <b>Si</b>             |
| <b>Equipo</b>                       | <b>DALI</b>           |
| <b>Flicker Free</b>                 | <b>Si</b>             |
| <b>Light source</b>                 | <b>LED</b>            |
| <b>Type of LED</b>                  | <b>COB</b>            |
| <b>Temperatura de color (K)</b>     | <b>3000</b>           |
| <b>Consistencia de color (SDCM)</b> | <b>SDCM&lt;3</b>      |
| <b>CRI</b>                          | <b>80</b>             |