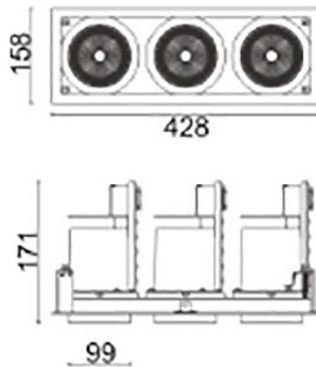

**D-TUBE3**

Downlight Lavov de la familia D-TUBE con una potencia de 105W, CRI>80 y un haz de 12 grados. Fabricado en aluminio inyectado a presión acabado en color Blanco. Flujo real de 9210lm. Eficacia luminosa de 87,71lm/W. ON/OFF driver.

Código artículo	86.D012.3411.01
Tipo de producto	Indoor
Categoría	Downlights
Familia	D-TUBE
Subfamilia	D-TUBE3
Pictograms	

Esquema

Producto	
Potencia real (W)	105
Flujo luminoso real (lm)	9210
Eficacia luminosa (lm/W)	87.714285714286007
Ángulo de apertura	12
Life time (h)	50000 h L80B10
IP	20
Color	Blanco
Driver incluido	Si
Equipo	ON/OFF
Flicker Free	Si
Light source	LED
Type of LED	COB
Temperatura de color (K)	4000
Consistencia de color (SDCM)	SDCM<3
CRI	80