



MINI F-T

Downlight Lavov de la familia MINI F-T con una potencia de 10W y un ángulo de apertura del haz de 36°. Acabado en color Negro. Version fija trimless. Con un flujo luminoso total de 951.6lm y una eficacia luminosa de 95.16lm/W. Fabricado en Aluminio inyectado a presión. Driver ON/OFF. CCT 2700K.





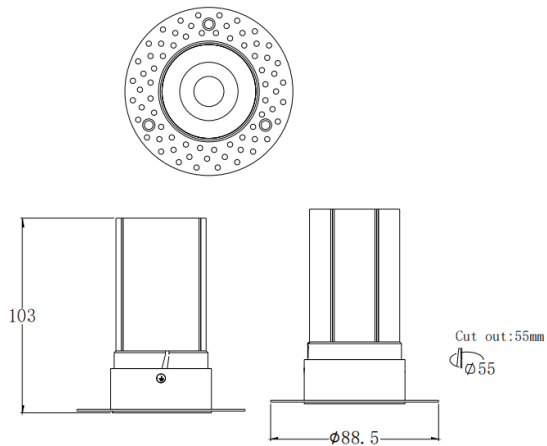

Dimensions

Product dimensions (mm) **ø88.5*H103mm**

Esquema



Curva fotométrica

Código artículo	86.D103.6231.02
Tipo de producto	Indoor
Categoría	Downlights
Familia	MINI
Subfamilia	MINI F-T
Pictograms	     

Producto	
Potencia real (W)	10
Flujo luminoso real (lm)	951.6
Eficacia luminosa (lm/W)	95.16
Ángulo de apertura	36
Tiempo de vida	50000 h L80B10
IP	20
Color	Negro
Driver incluido	Si
Equipo	ON/OFF
Flicker Free	Si
Fuente de luz	LED
Tipo de LED	COB
Temperatura de color (K)	2700
Consistencia de color (SDCM)	SDCM3
CRI	90

