



MINI A-T

Downlight Lavov de la familia MINI A-T con una potencia de 10W y un ángulo de apertura del haz de 24°. Acabado en color Negro. Version orientable trimless. Con un flujo luminoso total de 951.6lm y una eficacia luminosa de 95.16lm/W. Fabricado en Aluminio inyectado a presión. Driver DALI. CCT 2700K.

Dimensions

Product dimensions (mm) **ø88.5*H106.5mm**

Esquema

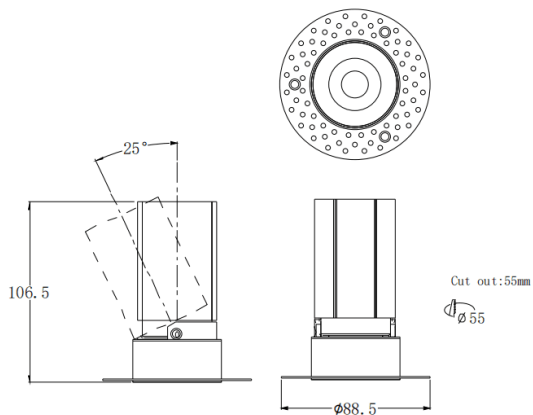

Curva fotométrica

Código artículo	86.D105.6223.02
Tipo de producto	Indoor
Categoría	Downlights
Familia	MINI
Subfamilia	MINI A-T
Pictograms	

Producto	
Potencia real (W)	10
Flujo luminoso real (lm)	951.6
Eficacia luminosa (lm/W)	95.16
Ángulo de apertura	24
Life time (h)	50000 h L80B10
IP	20
Color	Negro
Driver incluido	Si
Equipo	DALI
Flicker Free	Si
Light source	LED
Type of LED	COB
Temperatura de color (K)	2700
Consistencia de color (SDCM)	SDCM<3
CRI	90

