



LIGHT HOLE

Downlight Lavov de la familia LIGHT HOLE con una potencia de 10W, CRI>80 y un haz de 38 grados. Fabricado en aluminio inyectado a presión acabado en color Blanco. Flujo real de 900lm. Eficacia luminosa de 90lm/W. ON/OFF driver.

Código artículo	86.D116.1321.01
Tipo de producto	Indoor
Categoría	Downlights
Familia	LIGHT HOLE

Pictograms



Esquema

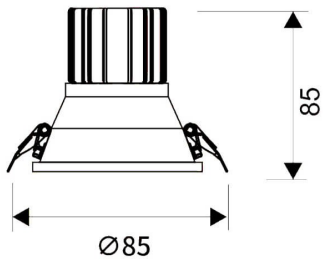

Producto

Potencia real (W)	10
Flujo luminoso real (lm)	900
Eficacia luminosa (lm/W)	90
Ángulo de apertura	38
Life time (h)	50000 h L80B10
IP	20
Color	Blanco
Driver incluido	Si
Equipo	ON/OFF
Flicker Free	Si
Light source	LED
Type of LED	COB
Temperatura de color (K)	3000
Consistencia de color (SDCM)	SDCM<3
CRI	80