

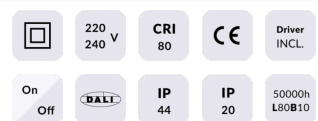

LIGHT HOLE

Downlight Lavov de la familia LIGHT HOLE con una potencia de 10W, CRI>80 y un haz de 40 grados. Fabricado en aluminio inyectado a presión acabado en color Blanco. Flujo real de 900lm. Eficacia luminosa de 90lm/W. DALI driver.

| | |
|-------------------------|---|
| Código artículo | 86.D416.1333.01 |
| Tipo de producto | Indoor |
| Categoría | Downlights |
| Familia | LIGHT HOLE |
| Pictograms |  |

Esquema

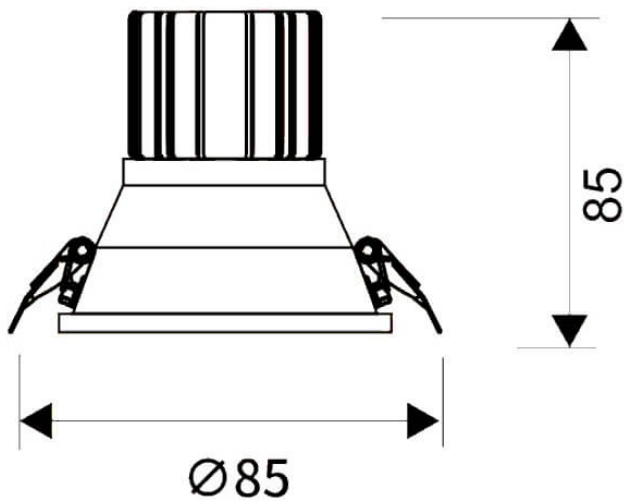

| | |
|-------------------------------------|-----------------------|
| Producto | |
| Potencia real (W) | 10 |
| Flujo luminoso real (lm) | 900 |
| Eficacia luminosa (lm/W) | 90 |
| Ángulo de apertura | 40 |
| Life time (h) | 50000 h L80B10 |
| IP | 20 |
| Color | Blanco |
| Driver incluido | Si |
| Equipo | DALI |
| Flicker Free | Si |
| Light source | LED |
| Type of LED | COB |
| Temperatura de color (K) | 3000 |
| Consistencia de color (SDCM) | SDCM<3 |
| CRI | 80 |