



LIGHT HOLE

Downlight Lavov de la familia LIGHT HOLE con una potencia de 10W, CRI>80 y un haz de 40 grados. Fabricado en aluminio inyectado a presión acabado en color Blanco. Flujo real de 900lm. Eficacia luminosa de 90lm/W. ON/OFF driver.

Código artículo 86.D517.1331.01

Tipo de producto Indoor

Categoría Downlights

Familia LIGHT HOLE

Pictograms

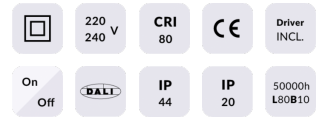

Esquema

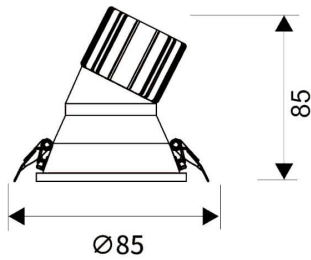

Producto

Potencia real (W) 10

Flujo luminoso real (lm) 900

Eficacia luminosa (lm/W) 90

Ángulo de apertura 40

Life time (h) 50000 h L80B10

IP 20

Color Blanco

Driver incluido Si

Equipo ON/OFF

Flicker Free Si

Light source LED

Type of LED COB

Temperatura de color (K) 3000

Consistencia de color (SDCM) SDCM<3

CRI 80