

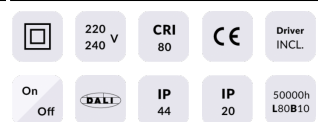

LIGHT HOLE

Downlight Lavov de la familia LIGHT HOLE con una potencia de 10W, CRI>80 y un haz de 24 grados. Fabricado en aluminio inyectado a presión acabado en color Blanco. Flujo real de 900lm. Eficacia luminosa de 90lm/W. DALI driver.

Código artículo	86.D517.1413.01
Tipo de producto	Indoor
Categoría	Downlights
Familia	LIGHT HOLE
Pictograms	

Esquema

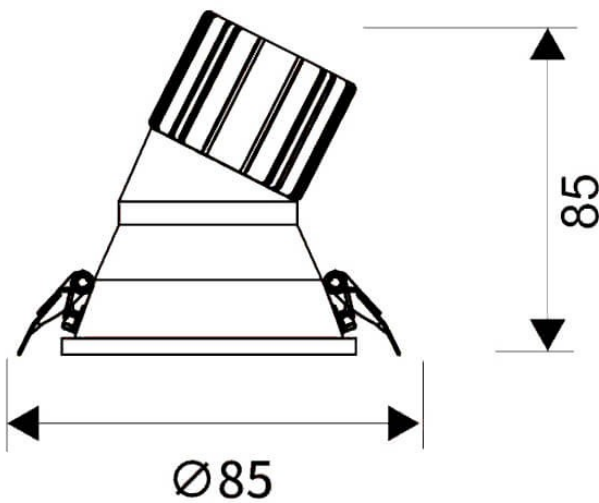

Producto	
Potencia real (W)	10
Flujo luminoso real (lm)	900
Eficacia luminosa (lm/W)	90
Ángulo de apertura	24
Life time (h)	50000 h L80B10
IP	20
Color	Blanco
Driver incluido	Si
Equipo	DALI
Flicker Free	Si
Light source	LED
Type of LED	COB
Temperatura de color (K)	4000
Consistencia de color (SDCM)	SDCM<3
CRI	80