

NEON 2835

Tira de LED Lavov de la familia NEON 2835 con una potencia de 10W/m y un ángulo de apertura del haz de 114.3°. Dimensiones 10X10x5000mm, cut at 33,3mm, 180 LED/m 2835 type .Con un flujo luminoso total de 500lm/m y una eficacia luminosa de 50lm/W. CCT 3000K. CRI>90.

Código artículo	86.LN01.3300.90
Tipo de producto	Indoor
Categoría	Tiras LED
Familia	NEON LATERAL
Subfamilia	NEON 2835
Pictograms	<div style="display: flex; gap: 10px;"> <div style="border: 1px solid gray; border-radius: 5px; padding: 2px 5px;">CRI 90</div> <div style="border: 1px solid gray; border-radius: 5px; padding: 2px 5px;">Driver EXCL</div> <div style="border: 1px solid gray; border-radius: 5px; padding: 2px 5px;">IP 67</div> </div>

Dimensions	
Product dimensions (mm)	10X10x5000mm, cut at 33,3mm, 180 LED/m 2835 type

Esquema

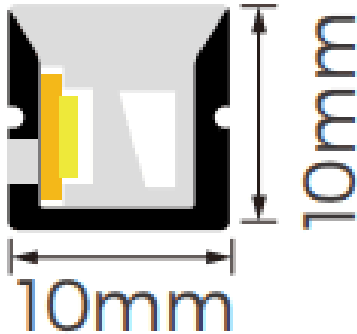

Producto	
Potencia real (W)	10
Flujo luminoso real (lm)	500
Eficacia luminosa (lm/W)	50
Ángulo de apertura	114.3
Tiempo de vida	30000h
IP	67
Electrical feeding	24V
Driver incluido	no
Fuente de luz	LED
Tipo de LED	2835
Temperatura de color (K)	3000
Consistencia de color (SDCM)	SDCM3
CRI	90