

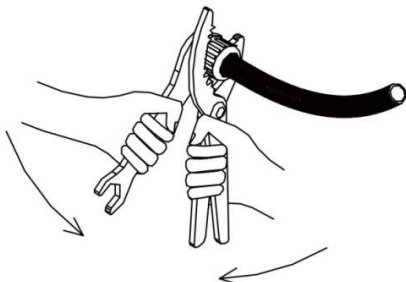

1-1.Put the wave tube through the nut and the rubber plug.  
#The wave tube should reach the bottom of the rubber plug#

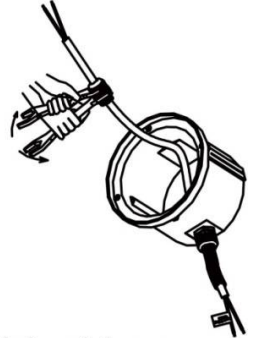

2-1.Fasten the nut with the screw by using a tool.



3-1.Put the cable through the wave tube and the hole of the mounting sleeve from outside .  
3-2.Then insert the cable into the nut/rubber plug and the screw of the PG13.5.  
3-3.Fix the nut with screw of the PG13.5 tightly.



4-1.Screw the PG13.5 with the connector on the wave tube tightly with two wrenches.  
4-2.Fix the backcover to the mounting sleeve by four screw.

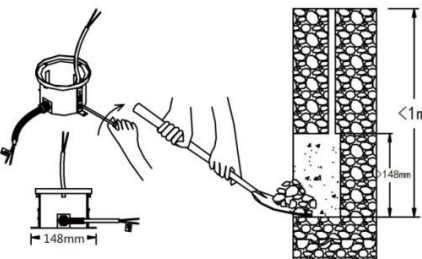

5-1.Fix the two type “L” bracket on the mounting sleeve.  
5-2.Dig a hole for the installation for each of the mounting sleeve.  
#The distance between these holes and the ground should less than 1m.#

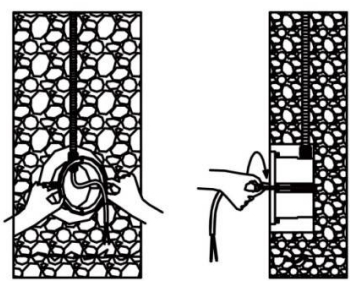

6-1.Put the mounting sleeve into the holes .  
6-2.Fasten it with the wall of the pool by a screwdriver .

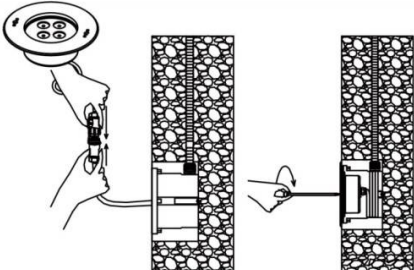

7-1.Connect the lighting fixture with the power cable by the connector .  
#fasten the connector tightly to make sure it can reach IP68.#  
7-2.Turn on the power to make sure it is working .  
7-3. Fix the light with the mounting sleeve by a screwdriver.

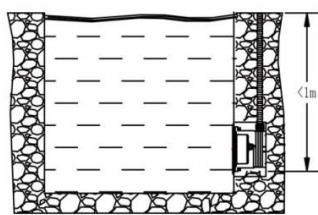

8-1.Pour the water into the pool after the installation.