



Rock up&down

Downlight de superficie Lavov de la familia Rock up&down con una potencia seleccionable de 28/32/35W y una optica de 150º down, 110º up grados.CCT 3000/4000/6000K seleccionable.Con un flujo luminoso total de 3300/3800/4200lm y una eficacia luminosa de 120 lm/W. Estabilidad de color SDCM<3 .CCT 3000/4000/6000K Driver On-off.Fabricado en Cuerpo y cubierta de PC y acabado en color blanco.Grados de proteccion IP54 y IK10. CRI>80.

Dimensions

Product dimensions (mm) **Ø450xH70mm**

Esquema

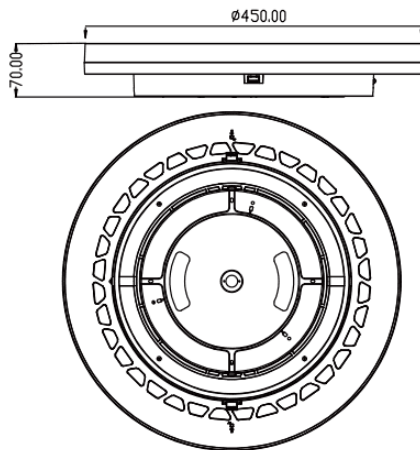

Código artículo	86.SD09.2301.01
Tipo de producto	Indoor
Categoría	Downlights de superficie
Familia	Rock
Subfamilia	Rock up&down
Pictograms	

Producto	
Potencia real (W)	28/32/35
Flujo luminoso real (lm)	3300/3800/4200
Eficacia luminosa (lm/W)	120
Ángulo de apertura	150º down, 110º up
IP	54
Color	blanco
Driver incluido	si
Equipo	On-off
Power Factor	>0,9
Flicker Free	si
Fuente de luz	LED
Tipo de LED	SMD
Temperatura de color (K)	3000/4000/6000
Consistencia de color (SDCM)	SDCM3
CRI	>80
IK	IK10