**INDOOR / PROYECTORES A CARRIL /
MICRO / MICRO 5**

Código artículo 86.T001.1313.01

LAVOV
LIGHTING



Please read all instructions before installation to avoid any problems.

Warning

1. Indoor lighting, protection level is IP20, do not use in high humidity condition
2. Working condition -20°C - +40°C, do not use in ultra high(low) temperature environment
3. Keep away from flammable and explosive environment
4. Do not cover the luminary with insulated liner or similar materials
5. Do not install at the place easy to loose, break and other instability surface
6. Do not impact or exert greater pressure on the lighting surface

Cautions

1. Power off before replacement
2. Don't touch the lamp when light
3. Don't use it in sealed fixture
4. If not bright, blink, dimming and other fault, please contact our service staff firstly instead of repairing it by yourself
5. Consult competent electricians for technical support

4 Wire (3-Phase) Track Rail and Adapter Type

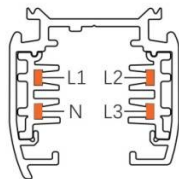

4 Wire (3-Phase) Rail

Adapter

Integrated Adapter

Adapter Installation Instructions

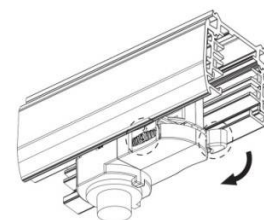
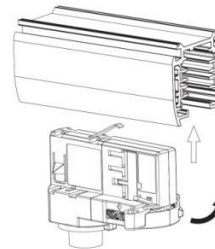
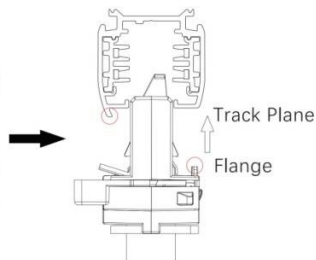
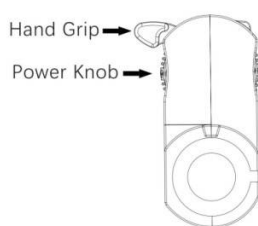

1. Make sure the track adapter's positions are the same as the picture showed before installation.

2. The adapter flange is in the same direction with the track plane.

3. Track adapter into the track.

4. Revolve the hand grip in place, select the power knob: phase 1/ phase 2/ phase 3. Can swing clockwise and anticlockwise.

Remove Instructions

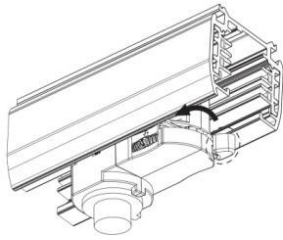

Turn the hand grip to the position as shown

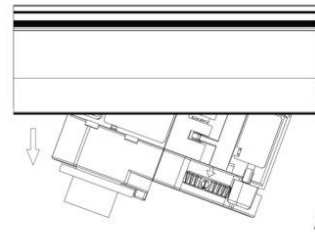

Remove the track adapter as shown

Integrated Adapter Installation Instructions

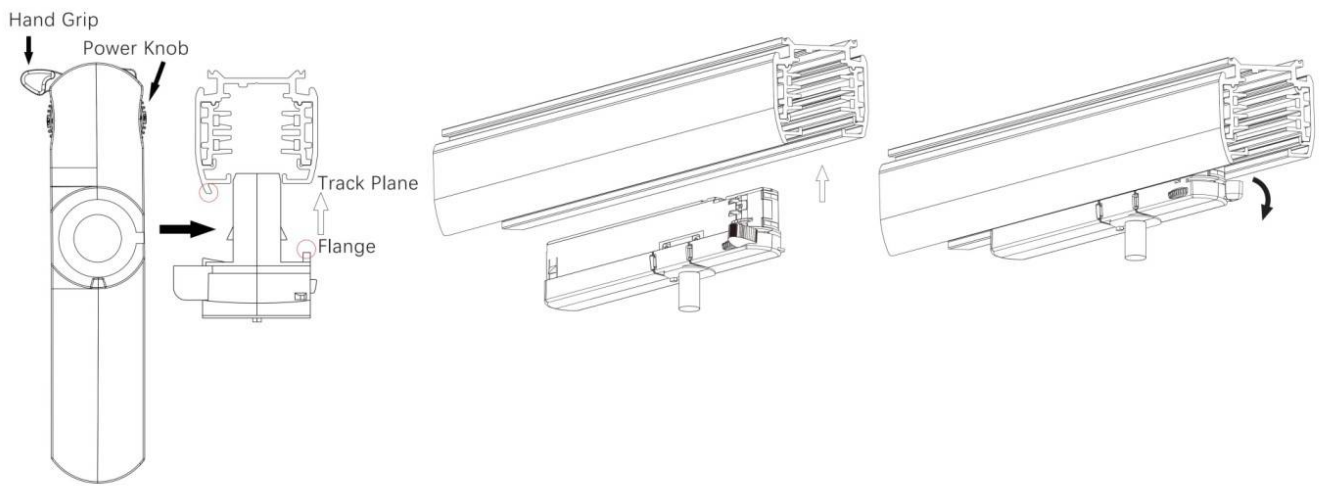

1. Make sure the track adapter's positions are the same as the picture showed before installation.

2. The adapter flange is in the same direction with the track plane.

3. Track adapter into the track.

4. Revolve the hand grip in place, select the power knob: phase 1/ phase 2/ phase 3. Can swing clockwise and anticlockwise.

Remove Instructions

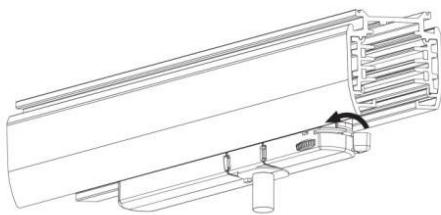

Turn the hand grip to the position as shown

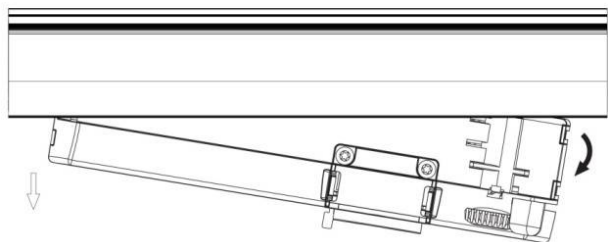

Remove the track adapter as shown