

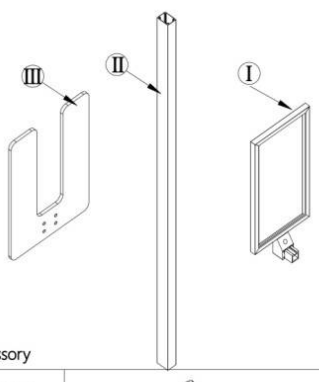

INTÉRIEURS / LUMINAIRES
ARCHITECTURAUX / WORKSTATION /
WORKSTATION FLOOR

Code article 86.A009.1392.01

LAVOV
L I G H T I N G

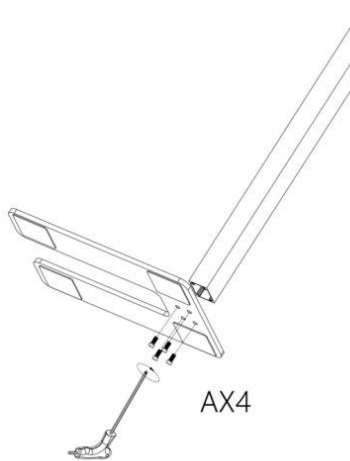
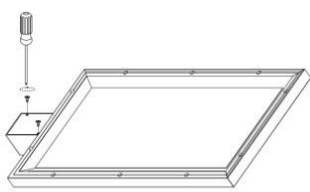
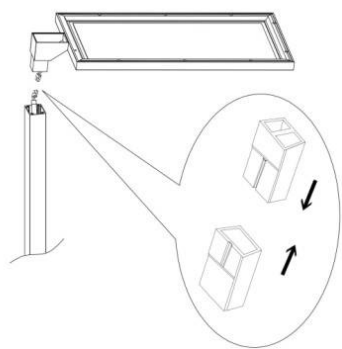

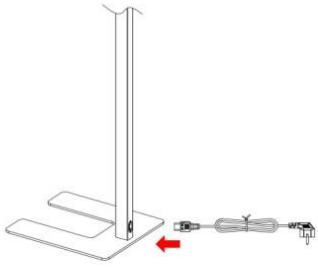
<p>①</p>  <p>Accessory</p> <table border="1"> <tr> <td>Screw A</td> <td></td> <td>AX4</td> </tr> <tr> <td>Screw B</td> <td></td> <td>BX4</td> </tr> <tr> <td>Cross point screwdriver</td> <td></td> <td>X1</td> </tr> <tr> <td>Hexagon screwdriver</td> <td></td> <td>X1</td> </tr> </table>	Screw A		AX4	Screw B		BX4	Cross point screwdriver		X1	Hexagon screwdriver		X1	<p>②</p>  <p>AX4</p> <p>Fix the bottom pole onto base plate</p>	<p>③</p>  <p>Open the box of lamp body</p>
Screw A		AX4												
Screw B		BX4												
Cross point screwdriver		X1												
Hexagon screwdriver		X1												
<p>④</p>  <p>Connect the terminals body</p>	<p>⑤</p>  <p>BX4</p> <p>Fix the lamp holder with the B screws</p>	<p>⑥</p>  <p>Close the box by screws</p>												
<p>⑦</p>  <p>Insert the tail of the AC cable into the terminal seat of lamp pole.</p>	<p>⑧</p> 