

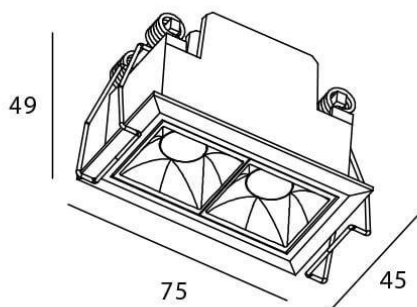











### Star

Downlight Lavov STAR, puissance 4 W, angle de faisceau de 30°. Température de couleur : 3 000 K. Flux lumineux total : 280 lm, efficacité lumineuse : 70 lm/W. Driver marche/arrêt. Boîtier en aluminium moulé sous pression, finition noire. UGR 19.

### Dessin technique



Code article	86.D029.2321.02
Type de produit	Intérieurs
Catégorie	Spots Encastrés
Famille	STAR
Sous-famille	Star
Pictograms	        

Produit	
Puissance système (W)	4
Flux lumineux utile (lm)	280
Efficacité lumineuse (lm/W)	70
Angle de faisceau	30
Durée de vie	50000 h L80B10
IP	20
Finition	Noir
U. G. R	UGR19
Driver intégré	oui
Équipement	ON/OFF
Flicker Free	oui
Source lumineuse	LED
Type de LED	COB
Température de couleur (K)	3000
Uniformité chromatique (SDCM)	SDCM3
CRI	90