

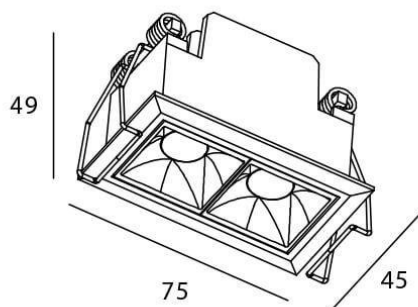











### Star

Downlight Lavov STAR, puissance 4 W, angle de faisceau de 15°.  
Température de couleur : 4 000 K. Flux lumineux total : 280 lm,  
efficacité lumineuse : 70 lm/W. Driver marche/arrêt. Boîtier en  
aluminium moulé sous pression, finition noire. UGR 19.

### Dessin technique



|                 |  |
|-----------------|--|
| Code article    | 86.D029.2411.02  |
| Type de produit | Intérieurs   |
| Catégorie       | Spots Encastrés  |
| Famille         | STAR   |
| Sous-famille    | Star   |
| Pictograms      |     <br>    |

|                               |                |
|-------------------------------|----------------|
| Produit                       |                |
| Puissance système (W)         | 4              |
| Flux lumineux utile (lm)      | 280            |
| Efficacité lumineuse (lm/W)   | 70             |
| Angle de faisceau             | 15             |
| Durée de vie                  | 50000 h L80B10 |
| IP                            | 20             |
| Finition                      | Noir           |
| U. G. R                       | UGR19          |
| Driver intégré                | oui            |
| Équipement                    | ON/OFF         |
| Flicker Free                  | oui            |
| Source lumineuse              | LED            |
| Type de LED                   | COB            |
| Température de couleur (K)    | 4000           |
| Uniformité chromatique (SDCM) | SDCM3          |
| CRI                           | 90             |