

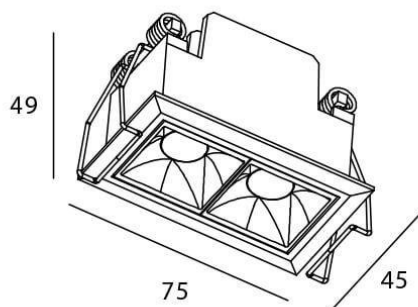











Star

Downlight Lavov STAR, puissance 4 W, angle de faisceau de 45°.
Température de couleur : 4 000 K. Flux lumineux total : 280 lm,
efficacité lumineuse : 70 lm/W. Driver marche/arrêt. Boîtier en
aluminium moulé sous pression, finition noire. UGR 19.

Dessin technique



| | |
|-----------------|--|
| Code article | 86.D029.2431.02 |
| Type de produit | Intérieurs |
| Catégorie | Spots Encastrés |
| Famille | STAR |
| Sous-famille | Star |
| Pictograms |          |

| | |
|-------------------------------|----------------|
| Produit | |
| Puissance système (W) | 4 |
| Flux lumineux utile (lm) | 280 |
| Efficacité lumineuse (lm/W) | 70 |
| Angle de faisceau | 45 |
| Durée de vie | 50000 h L80B10 |
| IP | 20 |
| Finition | Noir |
| U. G. R | UGR19 |
| Driver intégré | oui |
| Équipement | ON/OFF |
| Flicker Free | oui |
| Source lumineuse | LED |
| Type de LED | COB |
| Température de couleur (K) | 4000 |
| Uniformité chromatique (SDCM) | SDCM3 |
| CRI | 90 |