

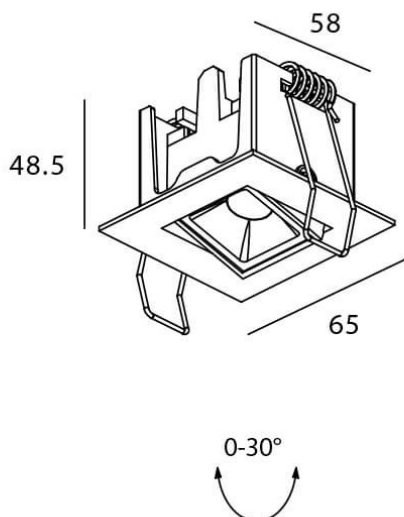











### Star-A

Downlight Lavov STAR, puissance 2 W, IRC > 90, angle de faisceau de 30°. Boîtier en aluminium moulé sous pression, finition noire. Flux lumineux réel de 90 lm. Efficacité lumineuse de 45 lm/W. Driver marche/arrêt.

### Dessin technique



Code article	86.D031.1421.02
Type de produit	Intérieurs
Catégorie	Spots Encastrés
Famille	STAR
Sous-famille	Star-A
Pictograms	        

Produit	
Puissance système (W)	2
Flux lumineux utile (lm)	90
Efficacité lumineuse (lm/W)	45
Angle de faisceau	30
Durée de vie	50000 h L80B10
IP	20
Finition	Noir
U. G. R	19
Driver intégré	oui
Équipement	ON/OFF
Source lumineuse	LED
Type de LED	COB
Température de couleur (K)	4000
Uniformité chromatique (SDCM)	SDCM3
CRI	90