

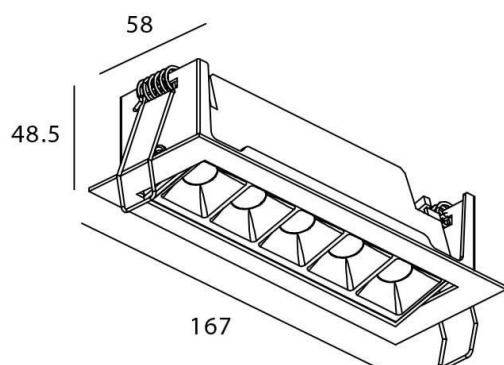

Star-A

Downlight Lavov STAR de 10 W, IRC > 90 et angle de faisceau de 15°. Fabriqué en aluminium moulé sous pression avec une finition blanche. Flux lumineux réel de 540 lm. Efficacité lumineuse de 54 lm/W. Driver DALI.

Dessin technique



Code article	86.D031.3413.01
Type de produit	Intérieurs
Catégorie	Spots Encastrés
Famille	STAR
Sous-famille	Star-A
Pictograms	        

Produit	
Puissance système (W)	10
Flux lumineux utile (lm)	540
Efficacité lumineuse (lm/W)	54
Angle de faisceau	15
Durée de vie	50000 h L80B10
IP	20
Finition	Blanc
U. G. R	19
Driver intégré	oui
Équipement	DALI
Source lumineuse	LED
Type de LED	COB
Température de couleur (K)	4000
Uniformité chromatique (SDCM)	SDCM3
CRI	90