











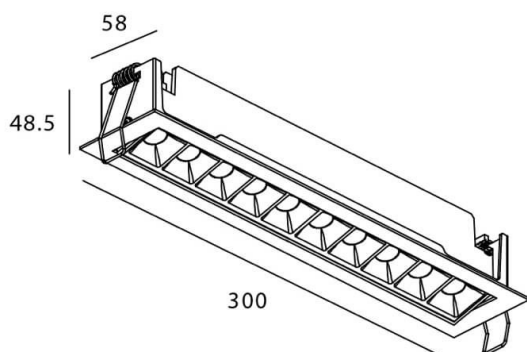

Star-A

Downlight Lavov STAR de 20 W, IRC > 90, faisceau large.

Fabriqué en aluminium moulé sous pression avec une finition blanche. Flux lumineux réel de 1220 lm. Efficacité lumineuse de 61 lm/W. Driver marche/arrêt.

Dessin technique



Code article	86.D031.4441.01
Type de produit	Intérieurs
Catégorie	Spots Encastrés
Famille	STAR
Sous-famille	Star-A
Pictograms	        

Produit	
Puissance système (W)	20
Flux lumineux utile (lm)	1220
Efficacité lumineuse (lm/W)	61
Angle de faisceau	Wall Washer
Durée de vie	50000 h L80B10
IP	20
Finition	Blanc
U. G. R	19
Driver intégré	oui
Équipement	ON/OFF
Source lumineuse	LED
Type de LED	COB
Température de couleur (K)	4000
Uniformité chromatique (SDCM)	SDCM3
CRI	90