



Trim cardan 2

Le spot encastré Lavov Cardan, de conception à deux cadres, offre une puissance de 2 x 25 W et un angle de faisceau de 50°. Finition noire. Il présente un flux lumineux total de 2 394 lm et une efficacité lumineuse de 95,76 lm/W. Fabriqué en aluminium moulé sous pression avec des lentilles en polycarbonate, il est équipé d'un driver DALI dimmable et d'une température de couleur de 3 000 K.







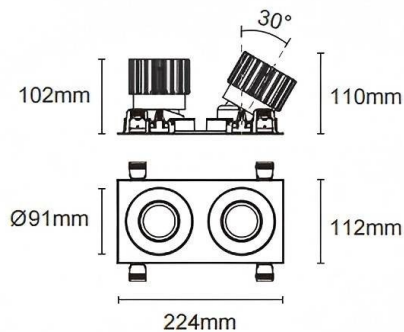



Dimensions

Product dimensions (mm) L224*W112*H110mm

Dessin technique



 Cut out : 102X212mm

Code article	86.D091.2333.02
Type de produit	Intérieurs
Catégorie	Spots Encastrés
Famille	Cardan
Sous-famille	Trim cardan 2
Pictograms	         

Produit	
Puissance système (W)	2x25
Flux lumineux utile (lm)	2x2394
Efficacité lumineuse (lm/W)	95.76
Angle de faisceau	50°
Durée de vie	50000hrs L80B10
IP	IP44
Finition	noir
Driver intégré	oui
Équipement	DALI dimmable
Flicker Free	oui
Source lumineuse	LED
Type de LED	COB
Température de couleur (K)	3000
Uniformité chromatique (SDCM)	SDCM3
CRI	90