



### Trim cardan 3

Le spot encastré Lavov Cardan, composé de trois modules de 17 W chacun et offrant un angle de diffusion de 30°, est disponible en noir. Il délivre un flux lumineux total de 1 580 lm et une efficacité lumineuse de 93 lm/W. Fabriqué en aluminium moulé sous pression avec des lentilles en polycarbonate, il est équipé d'un driver marche/arrêt (non dimmable). Température de couleur : 4 000 K.







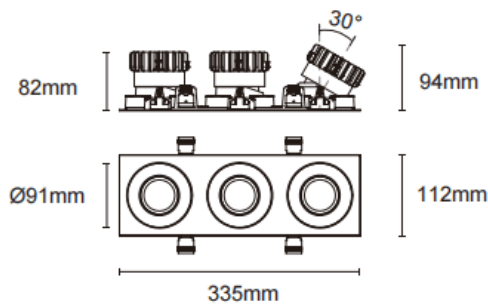



Dimensions	
Product dimensions (mm)	L335*H112*94mm

Dessin technique	
------------------	--



 Cut out : 102X323mm

Code article	86.D092.1421.02
Type de produit	Intérieurs
Catégorie	Spots Encastrés
Famille	Cardan
Sous-famille	Trim cardan 3
Pictograms	         

Produit	
Puissance système (W)	3x17
Flux lumineux utile (lm)	3x1580
Efficacité lumineuse (lm/W)	93
Angle de faisceau	30°
Durée de vie	50000hrs L80B10
IP	IP44
Finition	noir
Driver intégré	oui
Équipement	On-Off no dim
Flicker Free	oui
Source lumineuse	LED
Type de LED	COB
Température de couleur (K)	4000
Uniformité chromatique (SDCM)	SDCM3
CRI	90