



### Trim cardan 3

Le spot encastré Lavov Cardan, de conception à 3 cadres, offre une puissance de 3 x 17 W et un angle de faisceau de 30°.

Finition noire. Il présente un flux lumineux total de 1 580 lm et une efficacité lumineuse de 93 lm/W. Fabriqué en aluminium moulé sous pression avec des lentilles en polycarbonate, il est équipé d'un driver DALI dimmable et d'une température de couleur de 4 000 K.







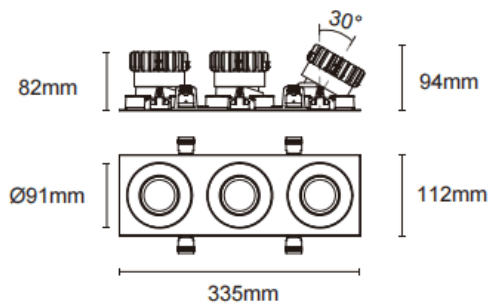



Dimensions	
Product dimensions (mm)	L335*H112*94mm

Dessin technique	
------------------	--



 Cut out : 102X323mm

Code article	86.D092.1423.02
Type de produit	Intérieurs
Catégorie	Spots Encastrés
Famille	Cardan
Sous-famille	Trim cardan 3
Pictograms	         

Produit	
Puissance système (W)	3x17
Flux lumineux utile (lm)	3x1580
Efficacité lumineuse (lm/W)	93
Angle de faisceau	30°
Durée de vie	50000hrs L80B10
IP	IP44
Finition	noir
Driver intégré	oui
Équipement	DALI dimmable
Flicker Free	oui
Source lumineuse	LED
Type de LED	COB
Température de couleur (K)	4000
Uniformité chromatique (SDCM)	SDCM3
CRI	90