





Trim cardan 3





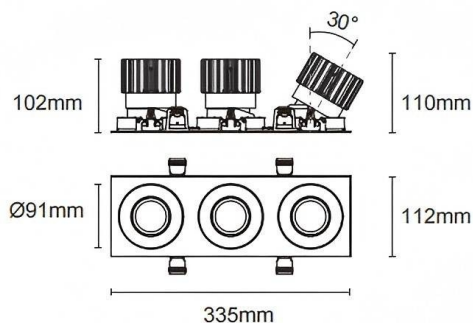





Le spot encastré Lavov Cardan, de la gamme Cardan, est composé de trois modules de 25 W chacun et offre un angle de faisceau de 30°. Sa finition blanche lui confère un flux lumineux total de 2 394 lm (3 x 2 394 lm) et une efficacité lumineuse de 95,76 lm/W. Fabriqué en aluminium moulé sous pression avec des lentilles en polycarbonate, il est équipé d'un driver DALI dimmable et d'une température de couleur de 3 000 K.

Dimensions	
Product dimensions (mm)	L335*H112*94mm

Dessin technique	
------------------	--



 Cut out : 102X323mm

Code article	86.D092.2313.01
Type de produit	Intérieurs
Catégorie	Spots Encastrés
Famille	Cardan
Sous-famille	Trim cardan 3
Pictograms	         

Produit	
Puissance système (W)	3x25
Flux lumineux utile (lm)	3x2394
Efficacité lumineuse (lm/W)	95.76
Angle de faisceau	30°
Durée de vie	50000hrs L80B10
IP	IP44
Finition	blanc
Driver intégré	oui
Équipement	DALI dimmable
Flicker Free	oui
Source lumineuse	LED
Type de LED	COB
Température de couleur (K)	3000
Uniformité chromatique (SDCM)	SDCM3
CRI	90