

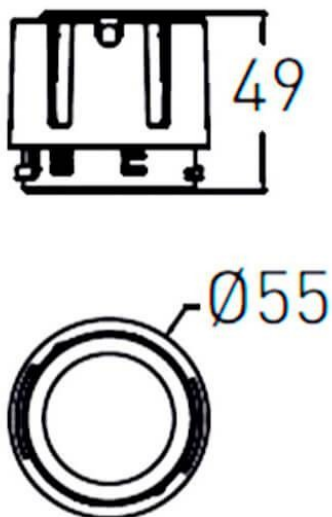











COMBO Modules

Downlight Lavov COMBO de 9 W, IRC > 90 et angle de faisceau de 6°. Fabriqué en aluminium moulé sous pression avec une finition gris argenté. Flux lumineux réel de 800 lm. Efficacité lumineuse de 93 lm/W. Driver DALI.

Dessin technique



Code article	86.D108.1343.02
Type de produit	Intérieurs
Catégorie	Spots Encastrés
Famille	COMBO
Sous-famille	COMBO Modules
Pictograms	         

Produit	
Puissance système (W)	9
Flux lumineux utile (lm)	800
Efficacité lumineuse (lm/W)	88.89
Angle de faisceau	55
Durée de vie	50000 h L80B10
IP	20
Finition	Noir
Driver intégré	oui
Équipement	DALI
Source lumineuse	LED
Type de LED	COB
Température de couleur (K)	3000
Uniformité chromatique (SDCM)	SDCM3
CRI	90