



### STAR Smart

Downlight Lavov STAR de 10 W avec optique Wall Washer.







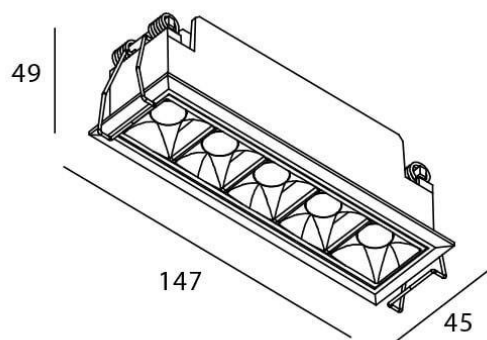

Température de couleur : 4 000 K. Flux lumineux total : 700 lm.

Efficacité lumineuse : 70 lm/W. Driver sans fil Casambi DALI+.

Boîtier en aluminium moulé sous pression, finition noire.

### Dessin technique



Code article	86.DS29.3449.02
Type de produit	Intérieurs
Catégorie	Spots Encastrés
Famille	STAR
Sous-famille	STAR Smart
Pictograms	        

Produit	
Puissance système (W)	10
Flux lumineux utile (lm)	700
Efficacité lumineuse (lm/W)	70
Angle de faisceau	Wall Washer
Durée de vie	50000 h L80B10
IP	20
Classe d'isolation	Classe II
Finition	noir
Équipement	DALI+ wireless Casambi
Source lumineuse	LED
Température de couleur (K)	4000
Uniformité chromatique (SDCM)	SDCM3
CRI	80