

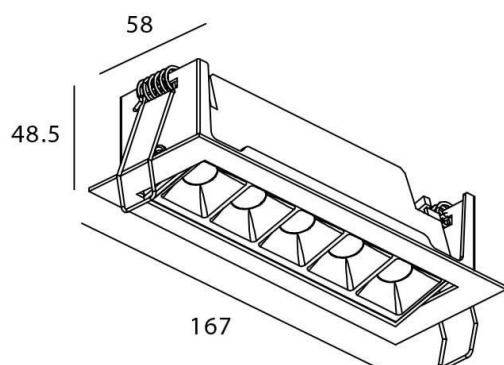











### STAR-A Smart

Downlight Lavov STAR de 10 W, IRC > 90 et angle de faisceau de 15°. Fabriqué en aluminium moulé sous pression avec une finition noire. Flux lumineux réel de 540 lm. Efficacité lumineuse de 54 lm/W. Gradation sans fil.

#### Dessin technique



Code article	86.DS31.3419.02
Type de produit	Intérieurs
Catégorie	Spots Encastrés
Famille	STAR
Sous-famille	STAR-A Smart
Pictograms	        

Produit	
Puissance système (W)	10
Flux lumineux utile (lm)	540
Efficacité lumineuse (lm/W)	54
Angle de faisceau	15
Durée de vie	50000 h L80B10
IP	20
Classe d'isolation	Classe II
Finition	noir
Équipement	DALI+ wireless Casambi
Source lumineuse	LED
Température de couleur (K)	4000
Uniformité chromatique (SDCM)	SDCM3
CRI	80