

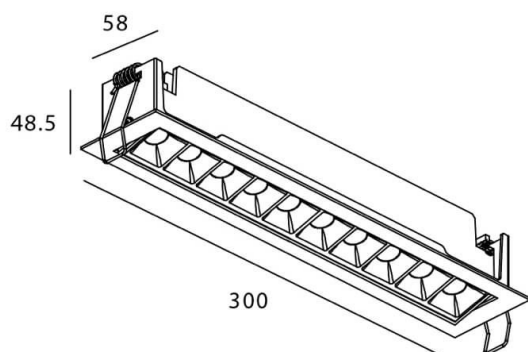











STAR-A Smart

Downlight Lavov STAR de 20 W, IRC > 90 et angle de faisceau de 30°. Fabriqué en aluminium moulé sous pression avec une finition noire. Flux lumineux réel de 1 220 lm. Efficacité lumineuse de 61 lm/W. Gradation sans fil.

Dessin technique



Code article	86.DS31.4429.02
Type de produit	Intérieurs
Catégorie	Spots Encastrés
Famille	STAR
Sous-famille	STAR-A Smart
Pictograms	        

Produit	
Puissance système (W)	20
Flux lumineux utile (lm)	1220
Efficacité lumineuse (lm/W)	61
Angle de faisceau	30
Durée de vie	50000 h L80B10
IP	20
Classe d'isolation	Classe II
Finition	noir
Équipement	DALI+ wireless Casambi
Source lumineuse	LED
Température de couleur (K)	4000
Uniformité chromatique (SDCM)	SDCM3
CRI	80