

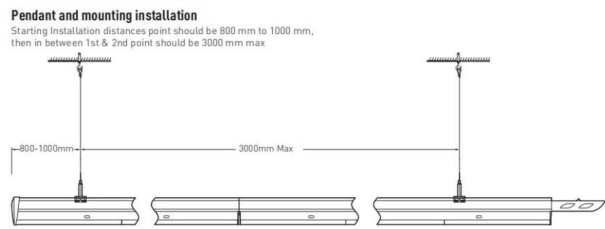

**Tracking and luminaire:**

First trunking rail should have one side connecting plate&last trunking rail with no connecting plate on both sides, then fix the Luminaire to trunking rail then lock holder, then keep end caps at both sides.

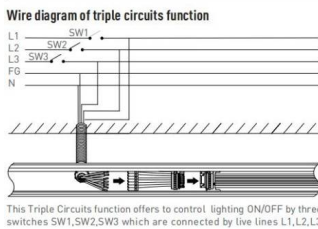
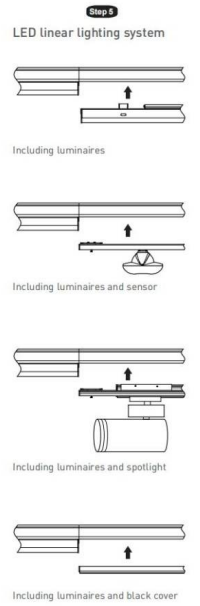
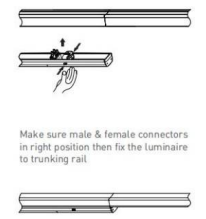
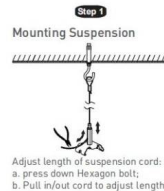
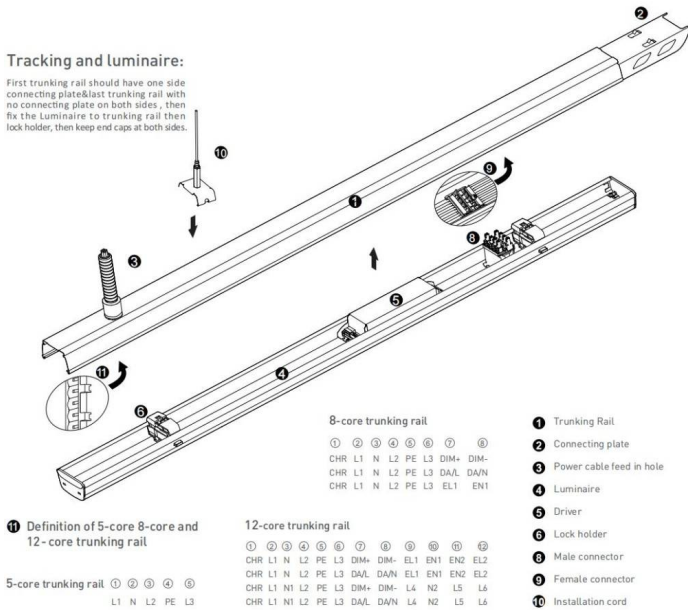

Safety notes:  
Installation should be performed only by qualified electrician.

- Make sure no voltage while installation.
- Connect cable wires according to wire labeling.
- Max current should not exceed 16A in one power feed in circuit.

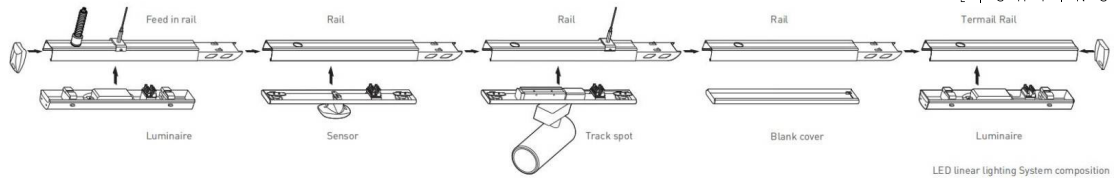

**Terminal module:**

Terminal module can be independently installed as a single unit, it also can be connected at end of one linear light row.

